

Technical Data

Specifications & Capacities

RTC 8050

Series II
Telescopic Boom Rough Terrain Crane
50 US ton
50 metric ton

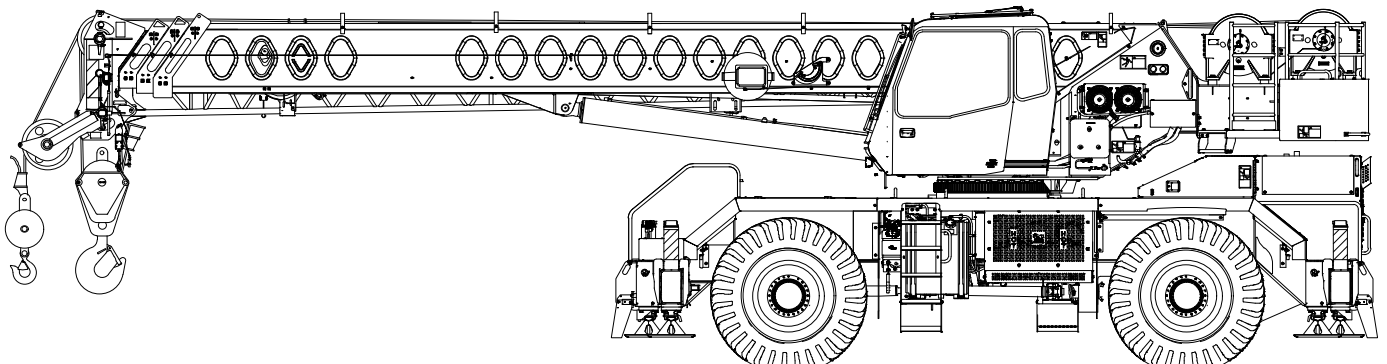

CAUTION: This material is supplied for reference use only. Operator must refer to in-cab Crane Rating Manual and Operator's Manual to determine allowable crane lifting capacities and assembly and operating procedures.

Table Of Contents

Boom, Attachments, and Upper Structure	1
Boom	1
Boom	1
Boom Head	1
Boom Elevation	1
Auxiliary Lifting Sheave – Optional	1
Hook Blocks and Balls – Optional	1
Fly – Optional	1
Operator’s Cab and Controls	1
Swing	3
Electrical	3
Load Hoist System	3
Load Hoist Performance	3
2M Main and Optional Auxiliary Winches	3
Hydraulic System	3
Counterweight	3
Carrier	4
General	4
Outriggers	4
Steering and Axles	4
Suspension	4
Tires and Wheels	4
Brakes	4
Electrical	4
Engine	4
Transmission	4
Maximum Speed	4
Fuel Tank	5
Hydraulic System	5
Pump Drive	5
Paint	5
Axle Loads	6
General Dimensions	7
Tier 4f / Stage IV	7
General Dimensions	8
Tier 3 / Stage IIIA	8
Working Range Diagram	9
Boom Extend Modes	10
Main Boom Lift Capacity Charts – Imperial	11
Fully Extended Outriggers – 360° Rotation	11
On Tires – Stationary – Boom Centered Over Front Between Tire Tracks	12
On Tires – Pick & Carry (Creep) – Boom Centered Over Front	12
On Tires – Stationary – 360° Rotation	12

Fly Attachment Lift Capacity Charts – Optional	13
Fully Extended Outriggers – 360° Rotation	13
110 ft Main Boom Length	
2° Fly Offset	13
110 ft Main Boom Length	
20° Fly Offset	13
110 ft Main Boom Length	
40° Fly Offset	13
Main Boom Lift Capacity Charts – 75% – Metric	14
Fully Extended Outriggers – 360° Rotation	14
On Tires – Stationary – Boom Centered Over Front Between Tire Tracks	15
On Tires – Pick & Carry (Creep) – Boom Centered Over Front	15
On Tires – Stationary – 360° Rotation	16
Fly Attachment Lift Capacity Charts – Optional – 75% (Metric)	16
Fully Extended Outriggers – 360° Rotation	16
33.53m Main Boom Length	
2° Fly Offset	16
33.53m Main Boom Length	
20° Fly Offset	16
33.53m Main Boom Length	
40° Fly Offset	16
Main Boom Lift Capacity Charts – 85% – Metric	17
Fully Extended Outriggers – 360° Rotation	17
On Tires – Stationary – Boom Centered Over Front Between Tire Tracks	18
On Tires – Pick & Carry (Creep) – Boom Centered Over Front	18
On Tires – Stationary – 360° Rotation	19
Fly Attachment Lift Capacity Charts – Optional – 85% (Metric)	19
Fully Extended Outriggers – 360° Rotation	19
33.53m Main Boom Length	
2° Fly Offset	19
33.53m Main Boom Length	
20° Fly Offset	19
33.53m Main Boom Length	
40° Fly Offset	19

Boom, Attachments, and Upper Structure

■ Boom

Design — Four section, box type construction of high tensile steel consisting of one base section and three telescoping sections. The vertical side plates have diamond shaped steel impressions for superior strength to weight ration. The first telescoping section extends independently by means of one double—acting, single stage hydraulic cylinder with integrated holding valves. The second and third telescoping sections extend proportionally by means of one double—acting, single stage cylinder with integrated holding valves and cables.

Boom

- 35 ft 6 in—110 ft (10.8—33.5m) four section full power boom
- Two mode boom extension: *A—max* mode provides superior capacities by extending the first telescoping section to 60 ft 4 in (18.4m). Standard mode synchronizes all the telescoping sections proportionally to 110 ft (33.5m). Controlled from the operator's cab.
- Mechanical boom angle indicator
- Maximum tip height for *A—max* mode is 70 ft (21.3m) and standard mode is 118 ft 5 in (36.1m).

Boom Head

- Four 16.5 in (41.9cm) root diameter nylon sheaves to handle up to eight parts of line
- Easily removable wire rope guards
- Rope dead end lugs on each side of the boom head
- Boom head is designed for quick—reeve of the hook block

Boom Elevation

- One double acting hydraulic cylinder with integral holding valve
- Boom elevation: -3° to 78°

Auxiliary Lifting Sheave — Optional

- Single 16.5 in (41.9m) root diameter nylon sheave
- Easily removable wire rope guards
- Does not affect erection of the fly or use of the main head sheaves

Hook Blocks and Balls — Optional

- 40 ton (36.3mt) 4 sheave quick—reeve hook block with safety latch
- 60 ton (54.4mt) 4 sheave quick—reeve hook block with safety latch
- 8.5 ton (7.7mt) swivel and non—swivel hook balls with safety latch

Fly — Optional

- 28 ft 6 in (8.7m) one piece lattice fly, stowable, offsettable to 2° , 20° , and 40° . Maximum tip height is 146 ft (44.5m).
- 28 ft 6 in—51 ft (8.7—15.5m) two piece bi—fold lattice fly, stowable, offsettable to 2° , 20° , and 40° . Maximum tip height is 168 ft (51.2m).

■ Operator's Cab and Controls

Environmental Cab — Fully enclosed, one person cab of galvaneal steel structure with acoustical insulation.

Equipped with:

- Tinted and tempered glass windows
- Extra—large fixed front window with windshield wiper and washer
- Swing up roof window with windshield wiper
- Sliding left side door with large fixed window
- Sliding rear and right side windows for ventilation
- Six way adjustable, cushioned seat with seat belt and storage compartment
- Diesel fired warm—water heater with air ducts for front windshield defroster and cab floor
- Defroster fan for the front window
- Bubble level
- Circulating fan
- Adjustable sun visor
- Dome light
- Cup holder
- Fire extinguisher
- Left side viewing mirror
- Two position travel swing lock
- AM/FM Radio

Air Conditioning — Optional — Integral with cab heating system utilizing the same ventilation outlets

Engine Dependent Heater — Optional — Flameless, warm—water system that does not have a separate fuel tank

Steering Column — Pedestal type with tilt and telescope functions for operator comfort. Column includes the following controls and indicators:

Left and right levers include:

- Horn button
- Turn signal switch
- Driving light switch
- Transmission direction switch

Panel mounted switches for:

- Travel park brake
 - Steer mode selector
 - 4 wheel drive
 - Transmission gear selector
 - Hazard flasher
- Panel mounted indicator/warning lights for:
- Transmission display
 - Transmission temperature
 - Engine oil pressure
 - Service brake
 - Turn signals
 - Rear wheel offset
 - Emergency steer — optional

Armrest Controls – Two dual axis hydraulic joystick controllers or optional single axis hydraulic controllers for:

- Swing
- Boom hoist
- Main rear winch
- Auxiliary front winch – optional
- Drum rotation indication
- Drum rotation indicator activation switch
- Winch high/low speed and disable switch(es)
- Third wrap selector switch – optional
- Telescopic override switches
- Warning horn button
- Swing park brake

Outrigger Controls – Hand held control box with umbilical cord gives the operator the freedom to view operation while setting the outriggers.

Foot Controls

- Boom telescope
- Swing brake
- Engine throttle

Right Front Console – Controls and indicators for:

- Engine ignition
- Engine throttle lock
- Function disable
- Front windshield wiper and washer
- Cab floodlights
- Warning horn
- Heating controls
- Console dimmer switch
- Bubble level
- 12 volt power connection
- Air conditioning – optional
- Boom floodlight – optional
- Rotating beacon/Strobe light – optional
- Third wrap indicator – optional
- E–stop switch

Cab Instrumentation – Ergonomically positioned LCD display, CAN bus instrumentation for crane operation including:

- Tachometer
- Engine water temperature
- Fuel level
- Hydraulic oil temperature
- Stop engine
- Check engine
- Wait to start
- Diesel exhaust fluid (DEF) level⁽¹⁾
- Engine air filter high restriction light⁽¹⁾
- Regeneration light⁽¹⁾
- Regeneration inhibit switch⁽¹⁾
- Regeneration initiate switch⁽¹⁾
- High exhaust temperature light⁽¹⁾
- Regeneration disabled light⁽¹⁾
- Swing park brake light
- Engine speed
- Engine oil pressure
- Battery voltage
- Fuel rate (gal/hr)
- Engine load
- Engine Diagnostics

Camera Display – Located on dash console

- Displays right side of upper
- Displays main and auxiliary winches
- Displays rear view

Diagnostic Center – Located behind the operator's seat.

- Engine diagnostic
- RCL CANBUS diagnostic
- Crane Controller USB diagnostic
- RCL controller USB diagnostic

⁽¹⁾ (Tier 4f / Stage IV engine only)

Link-Belt Pulse – The Link-Belt in-house designed, total crane operating system that utilizes the display as a readout and operator interface for the following systems:

- **Rated capacity limiter** – LCD graphic audio – visual warning system integrated into the dash with anti – two block and function limiter. Operating data includes:
 - Crane configuration
 - Boom length and angle
 - Boom head height
 - Allowed load and % of allowed load
 - RCL light bar
 - Outrigger position sensing
 - Drum rotation direction indication
 - Boom angle
 - Radius of load
 - Actual load
 - Wind speed
 - Highlighted unit of measurement on working screen
 - Third wrap indicator
 - Diagnostics
 - Operator settable alarms (include):
 - Maximum and minimum boom angles
 - Maximum tip height
 - Maximum boom length
 - Swing left/right positions
 - Operator defined area (imaginary plane)
- **Internal RCL Light Bar** – Visually informs the operator when crane is approaching maximum load capacity with a series of green, yellow, and red lights.
- **Telematics** – Cellular based data logging and monitoring system that provides:
 - Location and operational settings
 - Routine maintenance
 - Crane and engine monitoring
 - Diagnostic and fault codes

Integrated Third Wrap Indicator – Optional – Link–Belt Pulse color display visually and audibly warns the operator when the wire rope is on the first/bottom layer and when the wire rope is down to the last three wraps.

Integrated Third Wrap Function Kickout – Optional – Link–Belt Pulse color display visually and audibly warns the operator when the wire rope is on the first/bottom layer and provides a function kickout when the wire rope is down to the last three wraps.

External RCL Light Bar – Optional – Visually informs the ground crew when crane is approaching maximum load capacity with a series of green, yellow, and red lights.

■ Swing

Motor/Planetary — Bi-directional hydraulic swing motor mounted to a planetary reducer for 360° continuous smooth swing at 2.5 rpm.

Swing Park Brake — 360°, electric over hydraulic, (spring applied/hydraulic released) multi-disc brake mounted on the speed reducer. Operated by a switch from the operator's cab.

Swing Brake — 360°, foot operated, hydraulic applied disc brake mounted to the speed reducer.

Swing Lock — Two-position swing lock (boom over front or rear) operated from the operator's cab.

360° Positive Swing Lock — Optional — Meets New York City requirement.

■ Load Hoist System

Load Hoist Performance

Main (Rear) and Auxiliary (Front) Winches — 3/4 in (19mm) Rope										
Layer	Maximum Line Pull		Normal Line Speed		High Line Speed		Layer		Total	
	lb	kN	ft/min	m/min	ft/min	m/min	ft	m	ft	m
1	15,390	68.45	168	51.2	337	102.7	114	34.7	114	34.7
2	14,150	62.94	183	55.8	366	111.6	124	37.8	238	72.5
3	13,094	58.24	198	60.4	396	120.7	134	40.8	372	113.4
4	12,185	54.20	212	64.6	425	129.5	144	43.9	516	157.3
5	11,394	50.68	227	69.2	455	138.7	154	46.9	670	204.2

Wire Rope Application		Diameter		Type	Maximum Permissible Load	
		in	mm		lb	kg
Main (Rear) Winch	Standard	3/4	19	18x19 rotation resistant — right regular lay (Type RB)	12,920	5 860.5
	Optional	3/4	19	36x7 rotation resistant — right regular lay (Type ZB)	15,600	7 076.2
Auxiliary (Front) Winch	Standard	3/4	19	18x19 rotation resistant — right regular lay (Type RB)	12,920	5 860.5
	Optional	3/4	19	36x7 rotation resistant — right regular lay (Type ZB)	15,600	7 076.2

2M Main and Optional Auxiliary Winches

- Bi-directional gear-type (2-speed) hydraulic motors driven through planetary reduction unit for positive control under all load conditions.
- Grooved lagging
- Power up/down mode of operation
- Hoist drum cable follower
- Drum rotation indicator
- Drum diameter: 16 in (40.6cm)
- Rope length:
 - Main: 600 ft (182.9m)
 - Auxiliary: 600 ft (182.9m)
- Maximum rope storage: 834 ft (254.2m)
- Terminator style socket and wedge

■ Electrical

Swing Alarm — Audio warning device signals when the upper is swinging.

Lights

- Two LED working lights on front of the cab
- One amber strobe beacon on top of the cab
- One rotating amber beacon on top of the cab — optional
- One LED working light on top of cab — optional
- Boom floodlight — Single— optional
- Boom floodlight — Dual— optional
- Boom floodlight — High intensity remote controlled— optional

■ Hydraulic System

Counterbalance Valves — All hoist motors, boom extend cylinders, and boom hoist cylinders are equipped with counterbalance valves to provide load lowering and prevents accidental load drop when hydraulic power is suddenly reduced.

■ Counterweight

Total of 12,500 lb (5.7t) of counterweight bolted to the upper structure frame with capacities for the 12,500 lb (5.7t) configuration.

Carrier

General

- 10 ft 10.5 in (3.31m) wide
- 12 ft 7 in (3.83m) wheelbase (centerline of first axle to centerline of second axle).

Frame — Box—type, torsion resistant, welded construction made of high tensile steel. Equipped with front and rear towing and tie—down lugs, tow connections, and access ladders.

Outriggers

Boxes — Two double box, front and rear welded to carrier frame.

Beams and Jacks — Four single stage beams with Confined Area Lifting Capacities (CALC™) provide selectable outrigger extensions of full, intermediate, and retracted. Hydraulically controlled from the operator's cab with integral check valves.

Pontoons — Four lightweight, quick release, 19.25 x 19.25 in (48.90 x 48.90cm), steel pontoons with contact area of 370 in² (2 387cm²) can be stored for road travel in storage racks on the carrier.

Main Jack Reaction — 63,500 lb (28 803kg) force and 213 psi (1 469kPa) ground bearing pressure.

Steering and Axles

Steering — Four independent modes consisting of two wheel front, two wheel rear, four wheel, and crab. Each mode is controlled from the steering wheel and is selected by a switch in the operator's cab.

Drive — Two modes: 4 x 2 and 4 x 4 for off highway travel

Axle 1 — Steered, non—driven for 4 x 2 and steered, driven for 4 x 4

Axle 2 — Steered, driven

Suspension

Front — Rigid mount to the carrier frame

Rear — The rear axle is suspended on the oscillation cylinders with motion of the axle controlled by a four bar linkage system. The oscillation cylinders lockout when the upper structure rotates 2.5° past centerline.

- Hydro—gas rear suspension — optional

Tires and Wheels

Front and Rear — Four (single) 23.5 x 25—20 ply rating, earthmover type tires on steel disc wheels

- Spare tires and wheels — optional

Brakes

Service — Full hydraulic, dual circuit, disc type brakes on all wheel ends

Parking/Emergency — Spring loaded type, acting on front axle

Electrical

Three batteries provide 12 volt operation and starting

Lights

- Front lighting includes two main headlights, and two parking/directional indicators.
- Side lighting includes two parking/directional indicators per side.
- Rear lighting includes two parking/directional indicators, two parking/brake lights, and two reversing lights.
- Other equipment includes hazard/warning system, cab light, instrument panel light, and signal horn.

Engine

Specification	Cummins QSB	
Numbers of Cylinders	6	6
Cycle	4	4
Emissions Compliance Level:	Tier 4f/Stage IV ⁽¹⁾	Tier 3/Stage IIIA ⁽²⁾
Bore and Stroke: inch (mm)	4.21 x 4.88 (107 x 124)	4.21 x 4.88 (107 x 124)
Piston Displacement: in ³ (L)	408 (6.7)	408 (6.7)
Max. Brake Horsepower: hp (kW)	195 (145) @ 2,300 rpm	173 (129) @ 2,300 rpm
Peak Torque: ft lb (Nm)	590 (800) @ 1,500 rpm	590 (800) @ 1,400 rpm
Electric/starting systems: volts	12/12	12/12
Alternator: amps	160	160
Crankcase Capacity: qt (L)	15 (14.2)	15 (14.2)
<ul style="list-style-type: none"> • Water/fuel separator w/ heater and water in fuel (WIF) sensor • 120—volt block heater — Tier 4f / Stage IV • 220—volt block heater — Tier 3 / Stage IIIA • Grid heater — 200 amp • Mechanically driven, variable speed, engine controlled, viscous fan clutch • ⁽¹⁾ Can only be sold and/or operated where Tier 4f and Stage IV off—highway emission standards are accepted. • ⁽²⁾ Can only be sold and/or operated where Tier 3 and Stage IIIA off—highway emission standards are accepted. 		

Transmission

Powershift — Three speed with high/low range for 6 forward and 6 reverse gears. Front axle disconnect for two or four wheel drive. Front axle disconnect in high range.

Maximum Speed

19.6 mph (31.5 km/h)

■ Fuel Tank

One 75 gallon (283.9L) capacity tank

Diesel Exhaust Fluid (DEF) tank

- One 5 gal (18.9L) capacity tank

■ Hydraulic System

All functions are hydraulically powered allowing positive precise, control with independent or simultaneous operation of all functions.

Main Pumps

- Three fixed displacement gear pumps for the main and auxiliary winches, swing, boom hoist, and telescope circuits with a manual disconnect to aid during cold weather starts.
- One gear pump for the outriggers, power steering, brakes, and telescope circuits.
- One pressure compensated piston pump is used in the control and service brake circuits.
- Combined pump capacity of 139 gpm (526.2Lpm).

Hydraulic Reservoir – 131 gal (495.9L) capacity equipped with sight level gauge. Diffusers built in for deaeration.

Filtration – One 10 micron, full flow, line filter in the control circuit. All oil is filtered prior to return to sump tank.

Accessible for easy filter replacement.

■ Pump Drive

All pumps are mechanically driven by the diesel engine.

Main and auxiliary winches, swing, boom hoist, and telescope pumps are mounted to a mechanical pump disconnect on the transmission torque convertor to aid in cold weather starting.

■ Paint

Entire machine is pre-painted and oven baked with Highsolid Paint (2 part epoxy/polyester) and/or (2 part epoxy primer/2 part polyurethane top coat). Standard Link-Belt Red, Link-Belt Gray, and Gloss Black colors apply.

Axle Loads

Base crane with full tank of fuel	Gross Vehicle Weight ⁽¹⁾		Upper Facing Front				Upper Facing Rear			
			Front Axles		Rear Axles		Front Axles		Rear Axles	
	lb	kg	lb	kg	lb	kg	lb	kg	lb	kg
Tier 4f/Stage IV	74,659	33 865	34,622	15 705	40,036	18 161	33,449	15 173	41,209	18 693
Tier 3 Stage IIIA	74,175	33 646	34,610	15 699	39,565	17 947	33,290	15 101	40,885	18 546
23.5R25 tires and wheels	400	181	199	90	201	91	199	90	201	91
Pintle hook, front	13	6	18	8	-5	-2	18	8	-5	-2
Pintle hook, rear	13	6	-5	-2	18	8	-5	-2	18	8
Hydro—gas suspension	48	22	17	8	31	14	17	8	31	14
Winch roller — rear winch	75	34	-32	-14	107	48	104	47	-29	-13
Winch roller — front winch	75	34	-16	-7	91	41	88	40	-13	-6
2M auxiliary winch	89	40	-198	-90	286	130	283	128	-195	-88
600 ft (182.9m) of 3/4 in (19mm) wire rope on auxiliary winch	669	303	-88	-40	757	343	734	333	-65	-30
Air conditioning in operator's cab	161	73	48	22	113	51	107	49	54	25
360° swing lock	68	31	25	11	43	20	41	19	27	12
Emergency steer system	159	72	38	17	121	55	116	53	43	20
Fly storage brackets to boom base section for fly options	99	45	146	66	-47	-21	-51	-23	150	68
28.5 ft (8.68m) offset fly — stowed	1,291	585	2,237	1 015	-947	-430	-990	-449	2,281	1 035
28.5—51 ft (8.68—15.54m) offset fly — stowed	1,861	844	3,060	1 388	-1,199	-544	-1,263	-573	3,124	1 417
Floodlight to boom base section	10	5	23	10	-13	-6	-13	-6	23	10
60 ton (54.4mt) hook block at front/rear bumper	1,109	503	1,530	694	-421	-191	-459	-208	1,568	711
40 ton (36.3mt) hook ball at front/rear bumper	720	327	994	451	-274	-124	-298	-135	1,108	462
8.5 ton (7.7mt) hook ball at front/rear bumper	360	163	497	225	-137	-62	-149	-68	509	231
Auxiliary lifting sheave	91	41	257	117	-166	-75	-169	-77	260	118

Tire	Maximum Load @ 25 mph (40.2km/h)
23.5 x 25 (20—PR)	38,000 lb (17 600kg)
23.5R25 2 Star	37,500 lb (17 010kg)

(1) Adjust gross vehicle weight and axle loading according to component weight.

Note: All weights are ±3%.

General Dimensions

Tier 4f / Stage IV

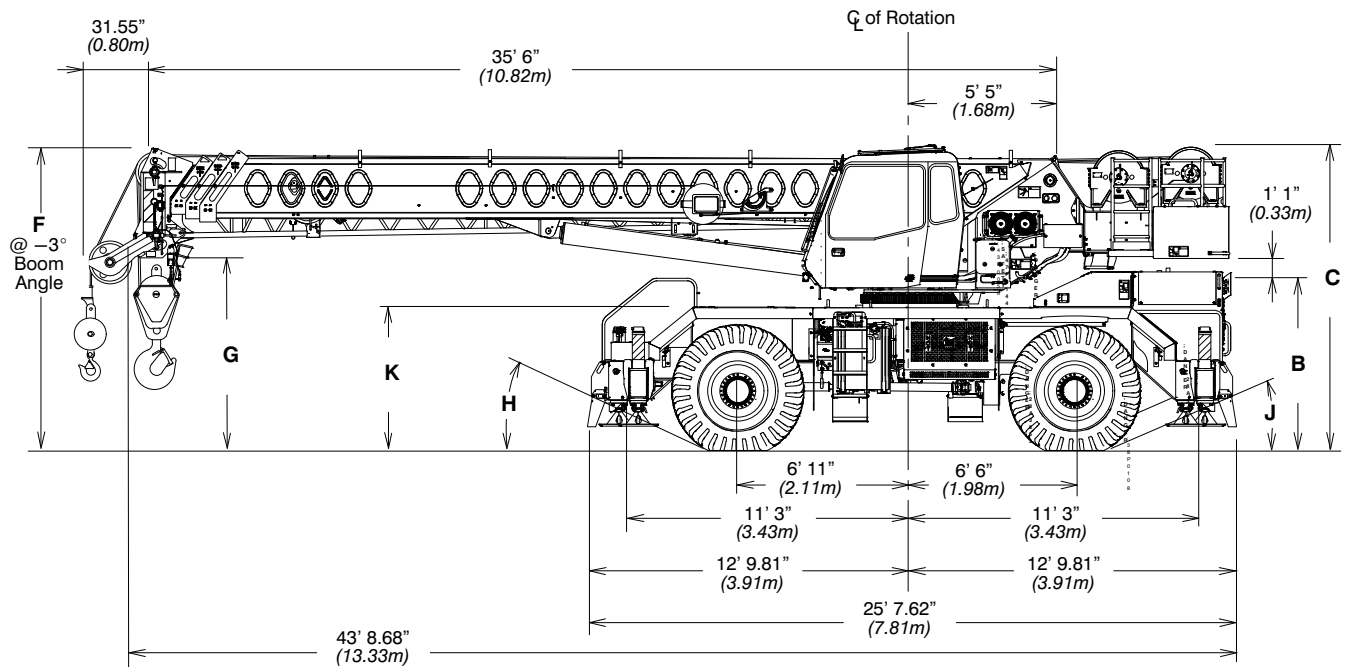

Turning Radius – Front Wheel (4x2) Steering		English	Metric
Wall to wall over carrier		39' 0"	11.9m
Wall to wall over boom		47' 7"	14.5m
Wall to wall over boom attachment		49' 7"	15.1m
Curb to curb		37' 3"	11.4m
Centerline of tire		36' 0"	11.0m

Turning Radius – All Wheel (4x4) Steering		English	Metric
Wall to wall over carrier		23' 4"	7.1m
Wall to wall over boom		34' 0"	10.4m
Wall to wall over boom attachment		35' 6"	10.8m
Curb to curb		21' 4"	6.5m
Centerline of tire		20' 0"	6.1m

Tail Swing		English	Metric
With counterweight		12' 8"	3.9m
Without counterweight		N/A	N/A

General Dimensions	Tire Size			
	23.5 x 25 bias		23.5R25 radial	
	English	Metric	English	Metric
A	10' 3.5"	3.14m	10' 3"	3.12m
B	6' 7.75"	2.03m	6' 9.5"	2.06m
C	11' 11.75"	3.65m	12' 1.5"	3.70m
D	7.75"	0.20m	7"	0.18m
E	10"	0.25m	11.75"	0.30m
F	10' 0.25"	3.05m	10' 2"	3.10m
G	7' 6"	2.29m	7' 7.75"	2.33m
H	24°	--	24.8°	--
J	21°	--	22°	--
K	6' 6.75"	1.69m	6' 8.5"	1.74m
L	8' 3"	2.51m	8' 3"	2.51m

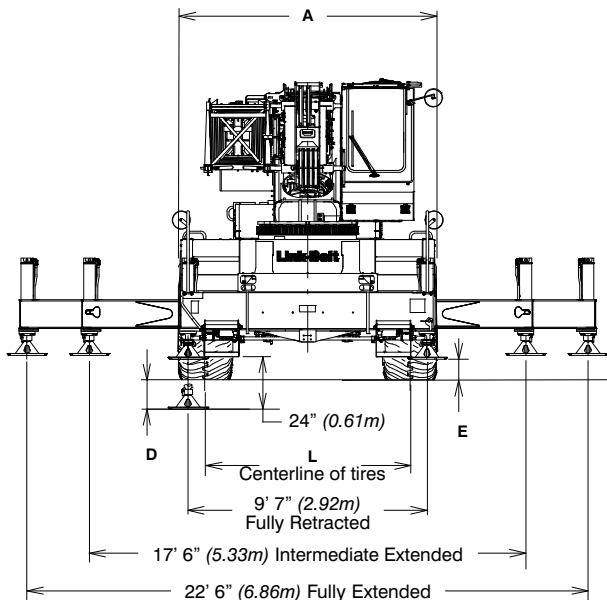

Not To Scale

General Dimensions

Tier 3 / Stage IIIA

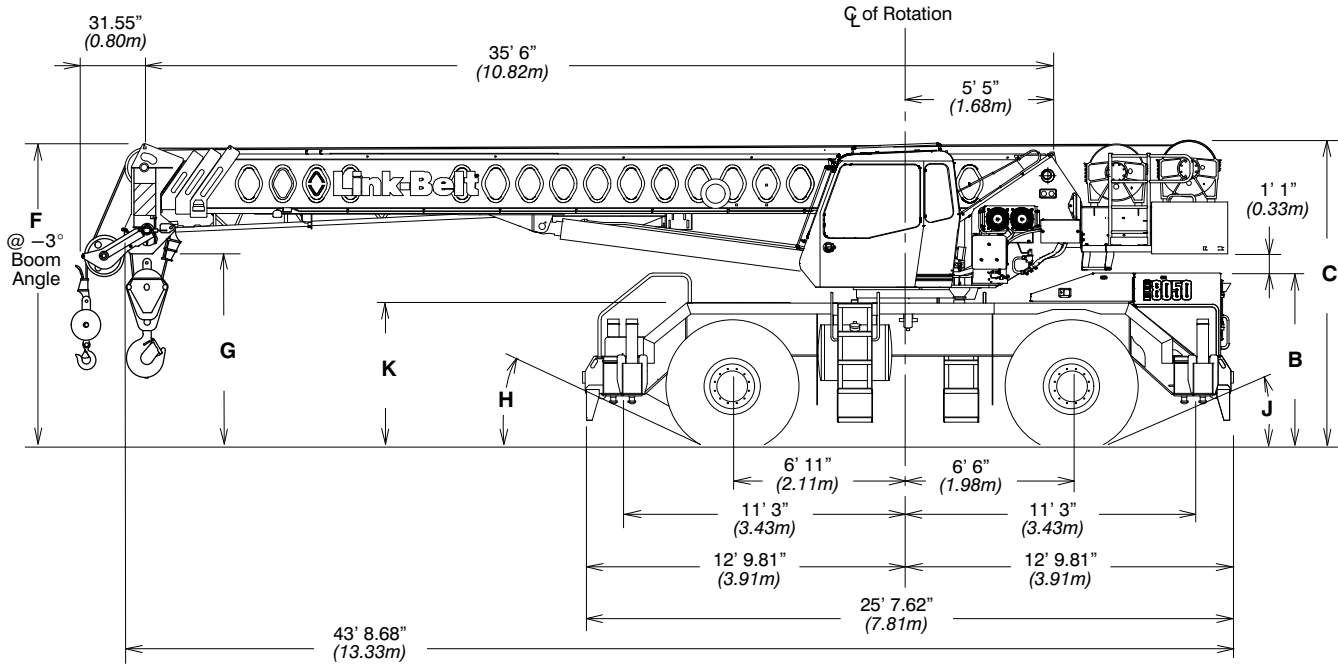

Turning Radius – Front Wheel (4x2) Steering	English	Metric
Wall to wall over carrier	39' 0"	11.9m
Wall to wall over boom	47' 7"	14.5m
Wall to wall over boom attachment	49' 7"	15.1m
Curb to curb	37' 3"	11.4m
Centerline of tire	36' 0"	11.0m

Turning Radius – All Wheel (4x4) Steering	English	Metric
Wall to wall over carrier	23' 4"	7.1m
Wall to wall over boom	34' 0"	10.4m
Wall to wall over boom attachment	35' 6"	10.8m
Curb to curb	21' 4"	6.5m
Centerline of tire	20' 0"	6.1m

Tail Swing	English	Metric
With counterweight	12' 8"	3.9m
Without counterweight	N/A	N/A

General Dimensions	Tire Size			
	23.5 x 25 bias		23.5R25 radial	
	English	Metric	English	Metric
A	10' 3.5"	3.14m	10' 3"	3.12m
B	6' 7.75"	2.03m	6' 9.5"	2.06m
C	11' 11.75"	3.65m	12' 1.5"	3.70m
D	7.75"	0.20m	7"	0.18m
E	10"	0.25m	11.75"	0.30m
F	10' 0.25"	3.05m	10' 2"	3.10m
G	7' 6"	2.29m	7' 7.75"	2.33m
H	24°	--	24.8°	--
J	21°	--	22°	--
K	6' 6.75"	1.69m	6' 8.5"	1.74m
L	8' 3"	2.51m	8' 3"	2.51m

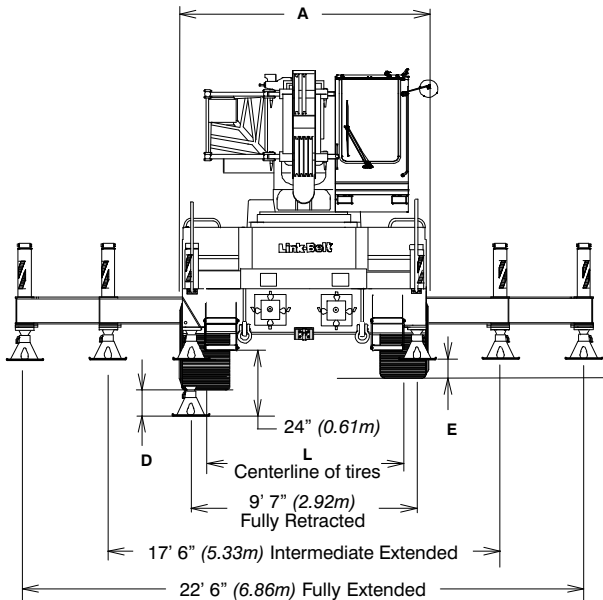

Not To Scale

Working Range Diagram

Working Range Diagram On Fully Extended Outriggers

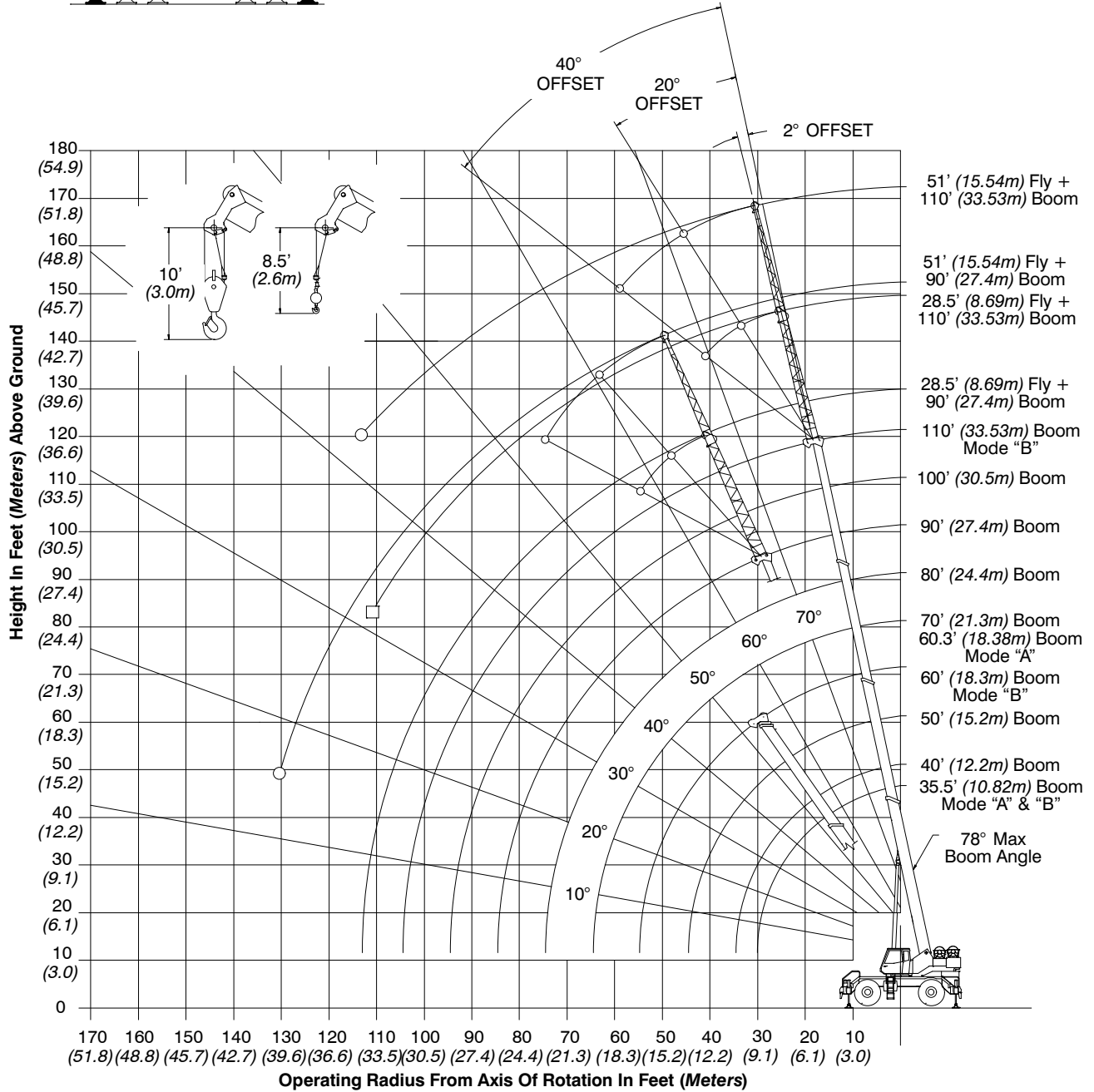

Boom Extend Modes

Boom Mode “A” (A-max)

Only inner mid section telescopes.

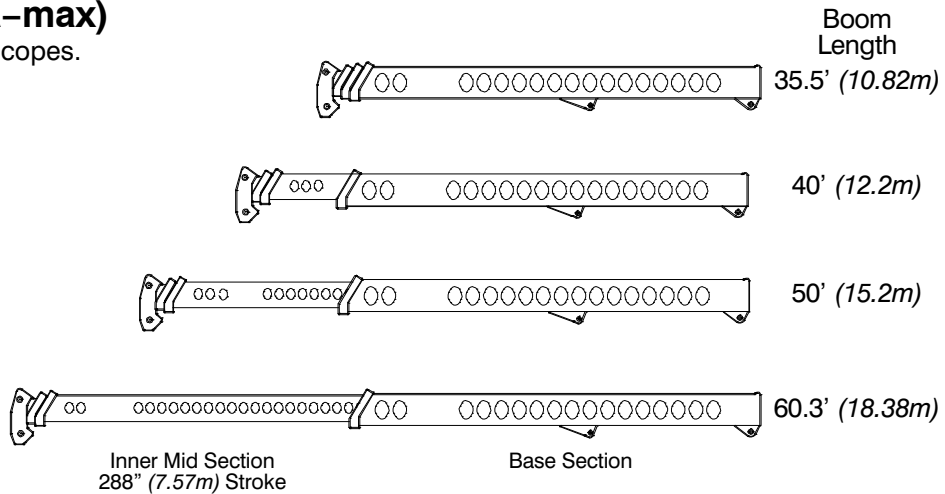

Boom Mode “B” (Standard)

Inner mid, outer mid, and tip sections telescope simultaneously.

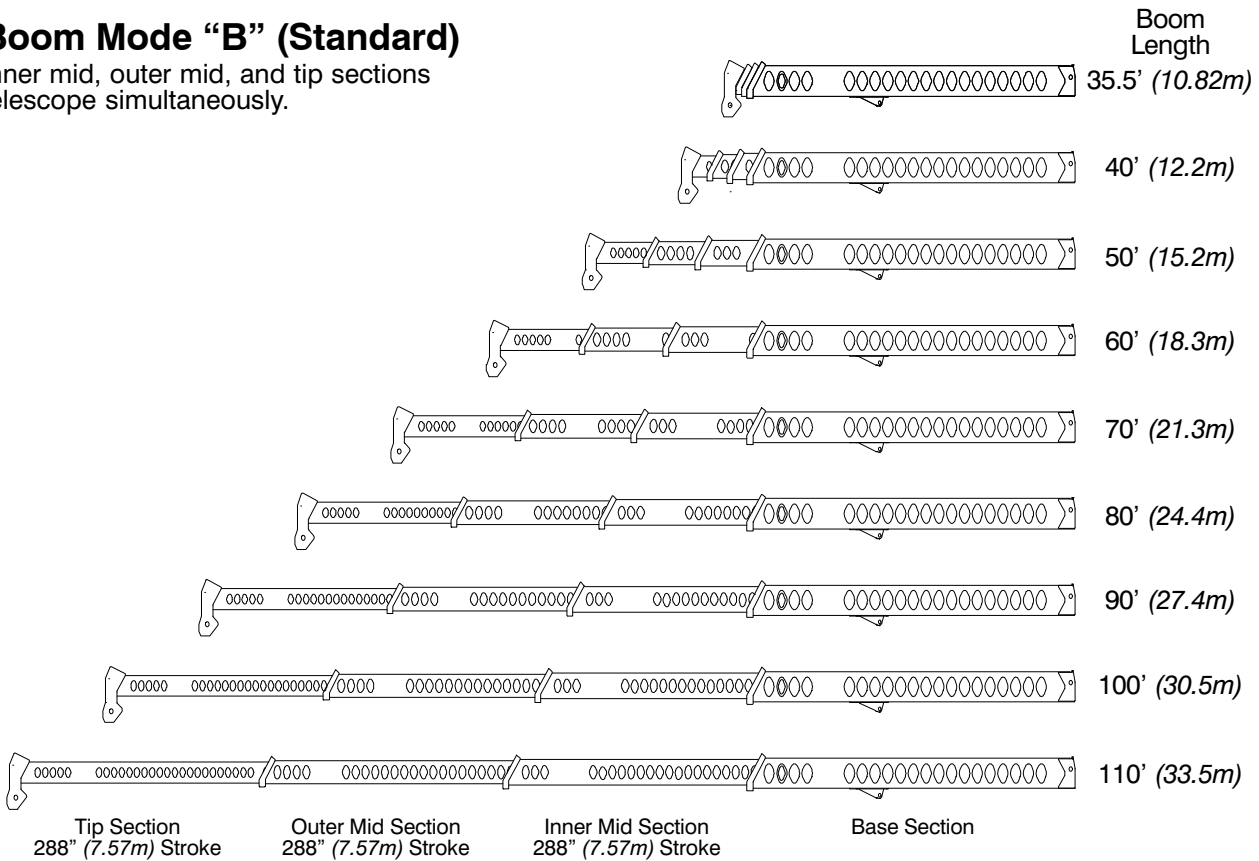

Main Boom Lift Capacity Charts – Imperial

Fully Extended Outriggers – 360° Rotation (All Capacities Are Listed In Pounds)										
Radius (ft)	Boom Length (ft)									Radius (ft)
	35.5	40	50	60/60.3	70	80	90	100	110	
10	100,000	78,400	72,600							10
12	73,900	73,100	65,600	50,900	37,900					12
15	63,200	63,000	57,500	46,900	37,900	35,400				15
20	50,300	50,100	47,600	39,200	37,900	34,700	28,900			20
25	39,000	38,900	38,500	37,900	37,900	34,200	28,200	24,000	19,500	25
30		31,300	31,900	32,300	32,500	30,300	24,800	22,500	19,500	30
35			26,100	26,500	26,700	26,900	22,000	19,900	18,300	35
40			20,800	21,200	21,400	21,500	19,700	17,800	16,400	40
45				17,100	17,300	17,400	17,500	15,900	14,600	45
50				13,900	14,200	14,300	14,400	14,400	13,200	50
55					11,900	12,100	12,200	12,200	12,100	55
60					10,000	10,200	10,300	10,300	10,400	60
65						8,600	8,700	8,800	8,900	65
70						7,300	7,500	7,500	7,600	70
75							6,400	6,500	6,500	75
80							5,400	5,500	5,600	80
85								4,700	4,800	85
90								4,000	4,100	90
95									3,500	95
100									2,900	100

This information is not for crane operation. Operator must refer to the in-cab information for crane operation. Rated lifting capacities shown on fully extended outriggers do not exceed 85% of the tipping loads and on tires do not exceed 75% of the tipping loads.

On Tires – Stationary – Boom Centered Over Front Between Tire Tracks (All Capacities Are Listed In Pounds)						
Radius (ft)	Boom Length (ft)					Radius (ft)
	35.5	40	50	60	70	
10	47,300	47,100				10
12	41,600	41,400				12
15	35,100	35,000	35,800			15
20	27,400	27,300	28,200	28,500		20
25	21,900	21,700	22,900	23,200	23,400	25
30		16,100	16,700	17,100	17,200	30
35			12,600	12,900	13,100	35
40			9,700	10,100	10,300	40
45				7,900	8,200	45
50				6,300	6,500	50
55					5,200	55
60					4,200	60

On Tires – Pick & Carry (Creep) – Boom Centered Over Front (All Capacities Are Listed In Pounds)						
Radius (ft)	Boom Length (ft)					Radius (ft)
	35.5	40	50	60	70	
10	44,100	43,900				10
12	38,400	38,200				12
15	31,800	32,000	32,400			15
20	24,000	24,300	24,700	25,000		20
25	18,600	19,000	19,500	19,800	19,900	25
30		15,100	15,600	15,900	16,100	30
35			12,600	12,900	13,100	35
40			9,700	10,100	10,300	40
45				7,900	8,200	45
50				6,300	6,500	50
55					5,200	55
60					4,200	60

On Tires – Stationary – 360° Rotation (All Capacities Are Listed In Pounds)						
Radius (ft)	Boom Length (ft)					Radius (ft)
	35.5	40	50	60	70	
10	37,200	37,400				10
12	31,100	31,400				12
15	24,000	24,400	24,900			15
20	14,500	14,800	15,400	15,700		20
25	9,400	9,800	10,300	10,700	10,900	25
30		6,600	7,100	7,500	7,700	30
35			5,000	5,300	5,500	35
40			3,400	3,700	3,900	40
45				2,500	2,700	45

This information is not for crane operation. Operator must refer to the in-cab information for crane operation. Rated lifting capacities shown on fully extended outriggers do not exceed 85% of the tipping loads and on tires do not exceed 75% of the tipping loads.

Fly Attachment Lift Capacity Charts – Optional

Fully Extended Outriggers – 360° Rotation (All Capacities Are Listed In Pounds)								
110 ft Main Boom Length 2° Fly Offset			110 ft Main Boom Length 20° Fly Offset			110 ft Main Boom Length 40° Fly Offset		
Radius (ft)	Fly Length (ft)		Radius (ft)	Fly Length (ft)		Radius (ft)	Fly Length (ft)	
	28.5	51		28.5	51		28.5	51
35	9,400		45	9,500		50	7,500	
40	9,400		50	9,100		55	7,300	
45	9,400	6,200	55	8,400		60	7,100	
50	9,400	6,200	60	7,800	4,800	65	6,900	
55	9,200	6,200	65	7,300	4,600	70	6,500	
60	8,500	6,200	70	6,800	4,400	75	6,100	3,400
65	7,900	6,000	75	6,400	4,300	80	5,800	3,400
70	7,300	5,700	80	6,000	4,100	85	5,500	3,300
75	6,800	5,300	85	5,700	4,000	90	5,200	3,200
80	6,200	4,900	90	5,000	3,800	95	4,600	3,200
85	5,300	4,600	95	4,300	3,700	100	3,900	3,100
90	4,600	4,300	100	3,700	3,500	105	3,300	3,100
95	4,000	4,000	105	3,200	3,300	110	2,800	3,000
100	3,500	3,800	110	2,700	3,200	115		2,900
105	3,000	3,500	115	2,300	3,000	120		2,800
110	2,500	3,000	120		2,600	125		2,400
115	2,100	2,600	125		2,200	130		2,000
120		2,200	130		1,900			

This information is not for crane operation. Operator must refer to the in-cab information for crane operation. Rated lifting capacities shown on fully extended outriggers do not exceed 85% of the tipping loads and on tires do not exceed 75% of the tipping loads.

Main Boom Lift Capacity Charts – 75% – Metric

Fully Extended Outriggers – 360° Rotation (All Capacities Are Listed In Kilograms)										
Radius (m)	Boom Length (m)									Radius (m)
	10.82	12.2	15.2	18.3/18.38	21.3	24.4	27.4	30.5	33.53	
2.5	50 000									2.5
3.0	45 350	35 550	33 250							3.0
3.5	34 550	34 050	30 550							3.5
4.0	31 550	31 350	28 350	23 050	17 150					4.0
4.5	29 000	28 900	26 350	21 450	17 150					4.5
5.0	26 750	26 700	24 650	20 200	17 150	16 050				5.0
6.0	23 100	23 050	21 850	17 950	17 150	15 700	13 100			6.0
7.0	19 650	19 600	19 450	17 150	17 150	15 700	13 100	10 850		7.0
8.0	16 650	16 850	17 100	17 150	16 600	15 050	12 400	10 850	8 800	8.0
9.0	13 000	14 400	14 700	14 800	14 900	13 850	11 400	10 300	8 800	9.0
10.0		11 700	12 050	12 150	12 200	12 250	10 500	9 500	8 750	10.0
12.0			8 550	8 700	8 800	8 850	8 900	8 200	7 550	12.0
14.0				6 550	6 650	6 700	6 750	6 750	6 500	14.0
16.0				5 050	5 200	5 250	5 300	5 350	5 350	16.0
18.0					4 100	4 200	4 250	4 250	4 300	18.0
20.0						3 350	3 400	3 450	3 450	20.0
22.0							2 700	2 800	2 850	22.0
24.0								2 250	2 350	24.0
26.0									1 850	26.0
28.0									1 500	28.0
30.0									1 250	30.0

This information is not for crane operation. Operator must refer to the in-cab information for crane operation. Rated lifting capacities shown on fully extended outriggers do not exceed 75% of the tipping loads and on tires do not exceed 65% of the tipping loads.

On Tires – Stationary – Boom Centered Over Front Between Tire Tracks (All Capacities Are Listed In Kilograms)						
Radius (m)	Boom Length (m)					Radius (m)
	10.82	12.2	15.2	18.3	21.3	
3	21 700					3
3.5	19 500	19 400				3.5
4	17 650	17 600				4
4.5	16 150	16 250	16 450			4.5
5	14 800	14 950	15 150			5
6	12 650	12 750	12 950	13 100		6
7	10 150	10 300	10 550	10 650	9 900	7
8	7 900	8 100	8 350	8 450	8 500	8
9	6 300	6 500	6 750	6 900	6 950	9
10		5 350	5 600	5 750	5 800	10
12			3 950	4 100	4 200	12
14				3 000	3 050	14
16				2 200	2 300	16
18					1 700	18

On Tires – Pick & Carry (Creep) – Boom Centered Over Front (All Capacities Are Listed In Kilograms)						
Radius (m)	Boom Length (m)					Radius (m)
	10.82	12.2	15.2	18.3	21.3	
3	20 250					3
3.5	18 000	17 950				3.5
4	16 200	16 300				4
4.5	14 600	14 750	14 900			4.5
5	13 250	13 400	13 550			5
6	11 050	11 200	11 400	11 500		6
7	9 350	9 500	9 700	9 850	9 900	7
8	7 900	8 100	8 350	8 450	8 500	8
9	6 300	6 500	6 750	6 900	6 950	9
10		5 350	5 600	5 750	5 800	10
12			3 950	4 100	4 200	12
14				3 000	3 050	14
16				2 200	2 300	16
18					1 700	18

This information is not for crane operation. Operator must refer to the in-cab information for crane operation. Rated lifting capacities shown on fully extended outriggers do not exceed 75% of the tipping loads and on tires do not exceed 65% of the tipping loads.

On Tires – Stationary – 360° Rotation (All Capacities Are Listed In Kilograms)						
Radius (m)	Boom Length (m)					Radius (m)
	10.82	12.2	15.2	18.3	21.3	
3	17 100					3
3.5	14 750	14 900				3.5
4	11 850	12 000				4
4.5	9 700	9 850	10 050			4.5
5	8 100	8 250	8 450			5
6	5 850	6 000	6 200	6 350		6
7	4 400	4 550	4 750	4 900	4 950	7
8	3 300	3 450	3 700	3 800	3 900	8
9	2 500	2 650	2 900	3 050	3 100	9
10		2 050	2 300	2 400	2 500	10
12			1 400	1 500	1 600	12
14					1 000	14

Fly Attachment Lift Capacity Charts – Optional – 75% (Metric)

Fully Extended Outriggers – 360° Rotation (All Capacities Are Listed In Kilograms)								
33.53m Main Boom Length 2° Fly Offset			33.53m Main Boom Length 20° Fly Offset			33.53m Main Boom Length 40° Fly Offset		
Radius (m)	Fly Length (m)		Radius (m)	Fly Length (m)		Radius (m)	Fly Length (m)	
	8.69	15.54		8.69	15.54		8.69	15.54
12	4 250		14	4 250		16	3 350	
14	4 250	2 800	16	4 000		18	3 250	
16	4 250	2 800	18	3 600	2 200	20	3 100	
18	3 900	2 800	20	3 300	2 100	22	2 850	1 600
20	3 550	2 700	22	3 000	1 950	24	2 650	1 550
22	3 050	2 500	24	2 750	1 850	26	2 400	1 500
24	2 550	2 250	26	2 300	1 800	28	2 000	1 450
26	2 100	2 050	28	1 900	1 700	30	1 650	1 400
28	1 750	1 900	30	1 550	1 650	32	1 350	1 400
30	1 450	1 650	32	1 250	1 500	34	1 050	1 350
32	1 150	1 350	34	1 000	1 300	36		1 200
34	950	1 150	36	800	1 100	38		950
36		950	38		900	40		750

This information is not for crane operation. Operator must refer to the in-cab information for crane operation. Rated lifting capacities shown on fully extended outriggers do not exceed 75% of the tipping loads and on tires do not exceed 65% of the tipping loads.

Main Boom Lift Capacity Charts – 85% – Metric

Fully Extended Outriggers – 360° Rotation (All Capacities Are Listed In Kilograms)												
Radius (m)	Boom Length (m)										Radius (m)	
	10.82	12.2	15.2	18.3	18.38	21.3	24.4	27.4	30.5	33.53		
2.5	50 000											2.5
3	45 350	35 550	33 250									3
3.5	34 550	34 050	30 550									3.5
4	31 550	31 400	28 350	17 150	23 050	17 150						4
4.5	29 000	28 900	26 400	17 150	21 500	17 150						4.5
5	26 750	26 700	24 650	17 150	20 200	17 150	16 050					5
6	23 100	23 050	21 850	17 150	17 950	17 150	15 700	13 100				6
7	19 650	19 600	19 400	17 150	16 150	17 150	15 700	13 100	10 850			7
8	16 650	16 850	17 100	17 150	14 500	16 600	15 100	12 400	10 850	8 800		8
9	13 000	14 500	14 800	14 950	13 200	15 050	13 900	11 400	10 300	8 800		9
10		12 600	12 900	13 100	12 100	13 200	12 950	10 550	9 550	8 750		10
12			9 700	9 900	8 850	10 000	10 050	9 100	8 200	7 550		12
14				7 450	6 450	7 550	7 600	7 650	7 100	6 500		14
16				5 750	4 800	5 900	5 950	6 000	6 000	5 750		16
18						4 650	4 750	4 800	4 850	4 850		18
20							3 800	3 900	3 900	3 950		20
22							3 100	3 150	3 200	3 200		22
24								2 550	2 600	2 650		24
26									2 100	2 150		26
28									1 700	1 750		28
30										1 400		30
32												32

This information is not for crane operation. Operator must refer to the in-cab information for crane operation. Rated lifting capacities shown on fully extended outriggers do not exceed 85% of the tipping loads and on tires do not exceed 75% of the tipping loads.

On Tires – Stationary – Boom Centered Over Front Between Tire Tracks (All Capacities Are Listed In Kilograms)							
Radius (m)	Boom Length (m)						Radius (m)
	10.82	12.2	15.2	18.3	18.38	21.3	
3	21 700						3
3.5	19 500	19 400					3.5
4	17 650	17 550					4
4.5	16 150	16 250	16 450				4.5
5	14 800	14 950	15 100				5
6	12 650	12 750	12 950	13 100	12 350		6
7	10 900	11 100	11 300	11 400	10 650	11 500	7
8	9 150	9 350	9 600	9 750	8 800	9 800	8
9	7 300	7 500	7 800	7 950	7 050	8 000	9
10		6 150	6 450	6 600	5 750	6 700	10
12			4 550	4 700	3 900	4 850	12
14				3 450	2 650	3 550	14
16				2 550	1 750	2 650	16
18						1 950	18

On Tires – Pick & Carry (Creep) – Boom Centered Over Front (All Capacities Are Listed In Kilograms)							
Radius (m)	Boom Length (m)						Radius (m)
	10.82	12.2	15.2	18.3	18.38	21.3	
3	20 250						3
3.5	18 000	17 950					3.5
4	16 200	16 300					4
4.5	14 600	14 750	14 900				4.5
5	13 250	13 400	13 550				5
6	11 050	11 200	11 400	11 500	10 800		6
7	9 350	9 500	9 700	9 850	9 100	9 900	7
8	7 950	8 100	8 350	8 450	7 750	8 550	8
9	6 800	7 000	7 200	7 350	6 600	7 450	9
10		6 050	6 300	6 450	5 700	6 500	10
12			4 550	4 700	3 900	4 850	12
14				3 450	2 650	3 550	14
16				2 550	1 750	2 650	16
18						1 950	18

This information is not for crane operation. Operator must refer to the in-cab information for crane operation. Rated lifting capacities shown on fully extended outriggers do not exceed 85% of the tipping loads and on tires do not exceed 75% of the tipping loads.

On Tires – Stationary – 360° Rotation (All Capacities Are Listed In Kilograms)							
Radius (m)	Boom Length (m)						Radius (m)
	10.82	12.2	15.2	18.3	18.38	21.3	
3	17 100						3
3.5	14 750	14 900					3.5
4	12 850	13 000					4
4.5	11 200	11 350	11 600				4.5
5	9 350	9 500	9 750				5
6	6 750	6 900	7 200	7 300	6 450		6
7	5 050	5 250	5 500	5 650	4 800	5 750	7
8	3 850	4 000	4 250	4 400	3 600	4 500	8
9	2 900	3 100	3 350	3 500	2 700	3 600	9
10		2 350	2 650	2 800	2 050	2 900	10
12			1 600	1 750		1 850	12
14						1 150	14

Fly Attachment Lift Capacity Charts – Optional – 85% (Metric)

Fully Extended Outriggers – 360° Rotation (All Capacities Are Listed In Kilograms)								
33.53m Main Boom Length 2° Fly Offset			33.53m Main Boom Length 20° Fly Offset			33.53m Main Boom Length 40° Fly Offset		
Radius (m)	Fly Length (m)		Radius (m)	Fly Length (m)		Radius (m)	Fly Length (m)	
	8.69	15.54		8.69	15.54		8.69	15.54
12	4 250		12			12		
14	4 250	2 800	14	4 300		14		
16	4 250	2 800	16	4 000		16	3 350	
18	3 900	2 800	18	3 600	2 200	18	3 250	
20	3 550	2 700	20	3 300	2 100	20	3 100	
22	3 250	2 500	22	3 000	1 950	22	2 850	1 600
24	2 900	2 250	24	2 800	1 850	24	2 650	1 550
26	2 400	2 100	26	2 600	1 800	26	2 500	1 500
28	2 000	1 900	28	2 150	1 700	28	2 250	1 450
30	1 650	1 750	30	1 800	1 650	30	1 850	1 400
32	1 350	1 550	32	1 450	1 500	32	1 500	1 400
34	1 100	1 300	34	1 150	1 400	34	1 200	1 350
36	850	1 050	36	900	1 250	36		1 300
38		850	38		1 000	38		1 100
40			40		800	40		850

This information is not for crane operation. Operator must refer to the in-cab information for crane operation. Rated lifting capacities shown on fully extended outriggers do not exceed 85% of the tipping loads and on tires do not exceed 75% of the tipping loads.

Link-Belt Construction Equipment Company Lexington, Kentucky www.linkbelt.com

®Link-Belt is a registered trademark. Copyright 2017. We are constantly improving our products and therefore reserve the right to change designs and specifications.